

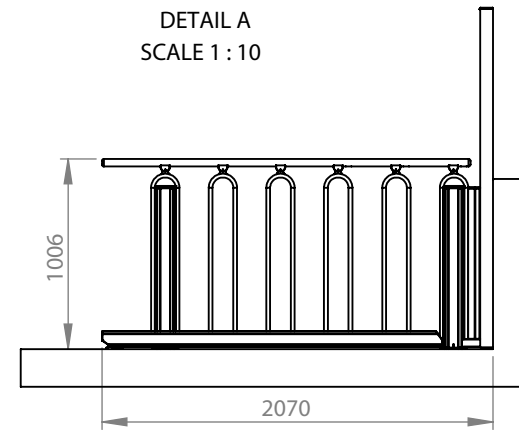

DETAIL A
SCALE 1 : 10

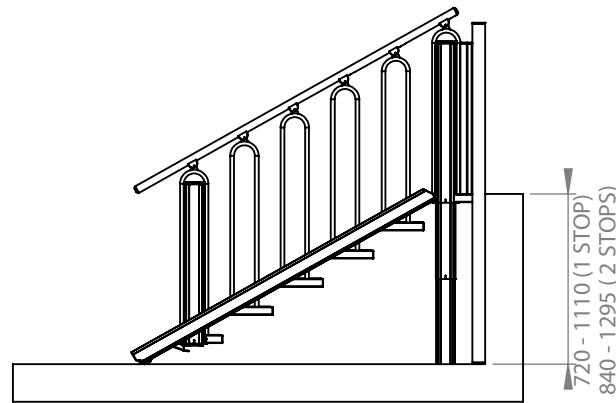

Minimum Installation Dimension
 1000 mm (model 700 mm)
 1100 mm (model 800 mm)
 1200 mm (model 900 mm)
 1300 mm (model 1000 mm)

Specs.	Choice	Model:	6 STEPS		 TRIDENT Product Name TRIDENT FLEXSTEP V2
Installation	Indoor	Balustrade:	Round	Last change date: 26-09-2016	
Handrails	Oak	Lifting Capacity:	400 kg	Customer :	Scale: 1:40 A4
Step Inserts	Oak	Drawn by:	EC		
Colour	Akzo Nobel 900				
Packing	Carton or Wood Pallet Box				
Op. Panel					



Position at top landing

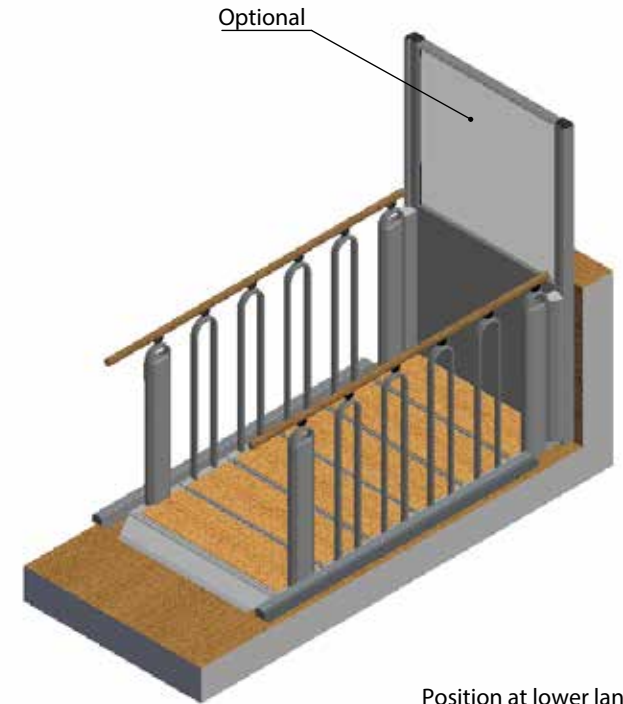

Position at lower landing



Staircase

Specs.	Choice	Model:	6 STEPS		 TRIDENT
Installation	Indoor	Balustrade:	Round	Last change date: 26-09-2016	
Handrails	Oak	Lifting Capacity:	400 kg	Customer :	Product Name
Step Inserts	Oak	Drawn by:	EC		TRIDENT FLEXSTEP V2
Colour	Akzo Nobel 900				Scale: 1:35
Packing	Carton or Wood Pallet Box				A4
Op. Panel					

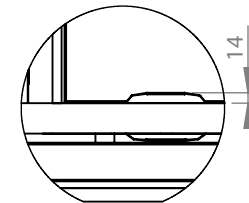
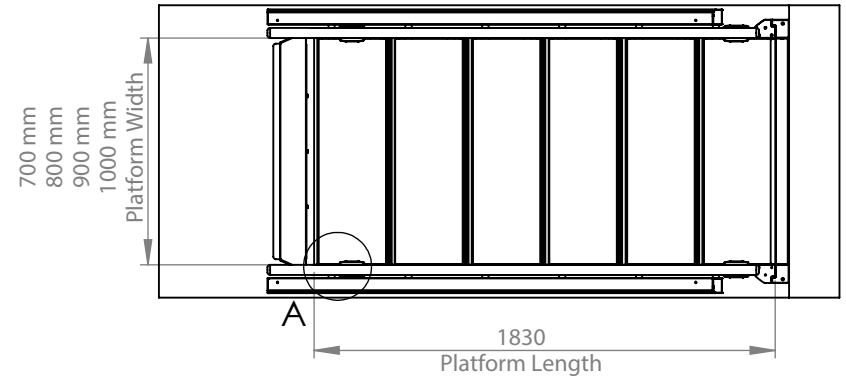
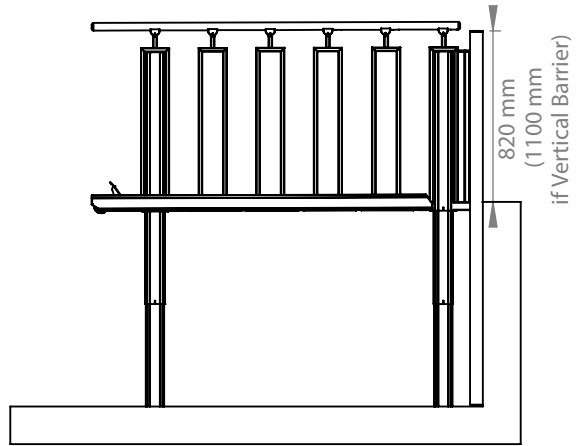
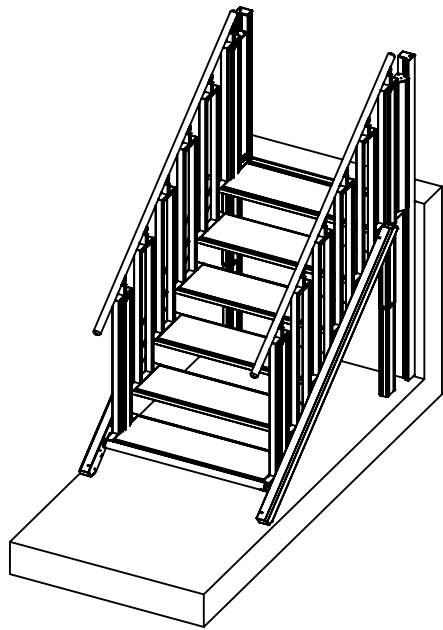

DETAIL A
SCALE 1 : 10

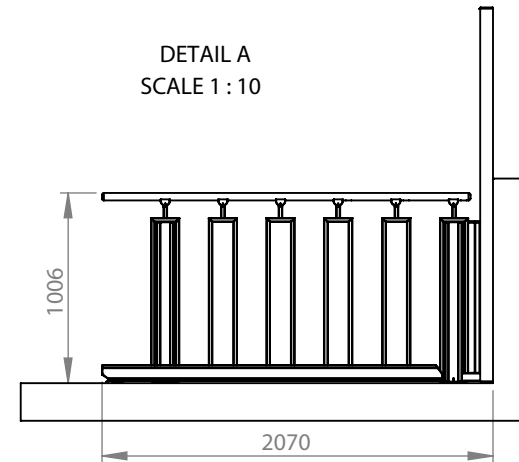
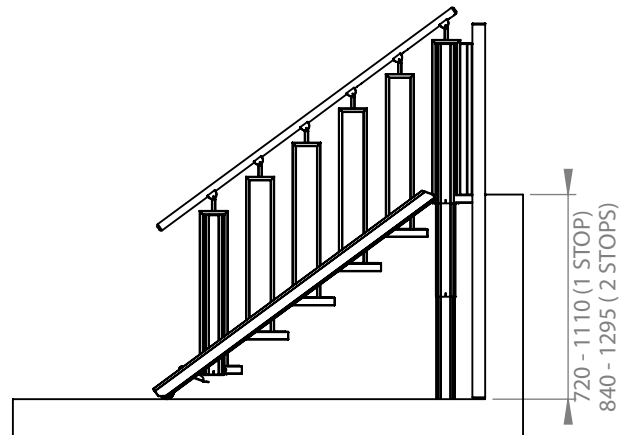

Minimum Installation Dimension
 1000 mm (model 700 mm)
 1100 mm (model 800 mm)
 1200 mm (model 900 mm)
 1300 mm (model 1000 mm)

Specs.	Choice	Model:	6 STEPS	 TRIDENT Product Name TRIDENT FLEXSTEP V2
Installation	Indoor	Balustrade:	Last change date: 26-09-2016	
Handrails	Oak		Square	Customer :
Step Inserts	Oak	Lifting Capacity:	400 kg	
Colour	Akzo Nobel 900	Drawn by:	EC	Scale: 1:40 A4
Packing	Carton or Wood Pallet Box			
Op. Panel				

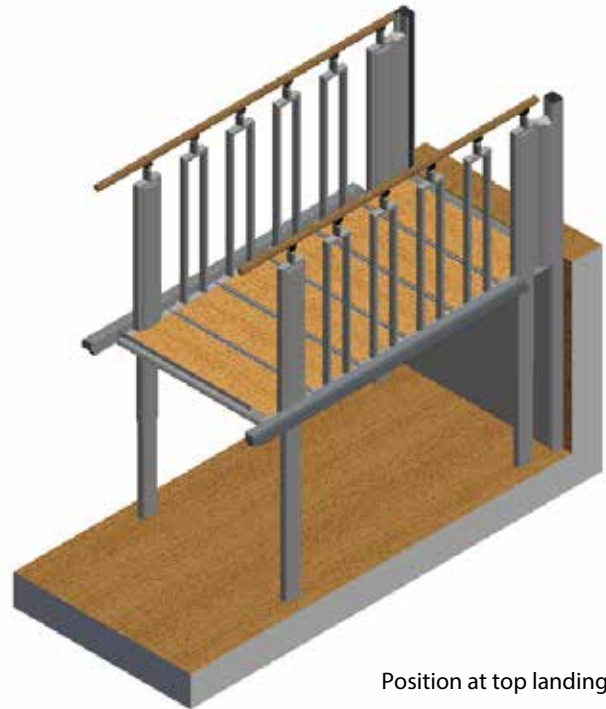

Position at top landing



Position at lower landing

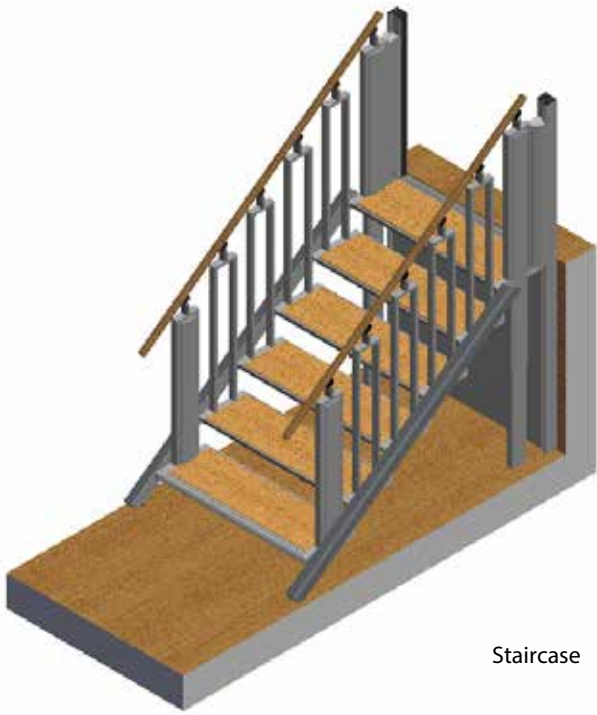

Staircase

Specs.	Choice	Model:	6 STEPS		 TRIDENT
Installation	Indoor	Balustrade:	Square	Last change date: 26-09-2016	
Handrails	Oak	Lifting Capacity:	400 kg	Customer :	Product Name
Step Inserts	Oak	Drawn by:	EC		TRIDENT FLEXSTEP V2
Colour	Akzo Nobel 900				Scale: 1:35
Packing	Carton or Wood Pallet Box				A4
Op. Panel					